

A **NEW** design in "Open Front" four post alignment Camber Neutral Technology

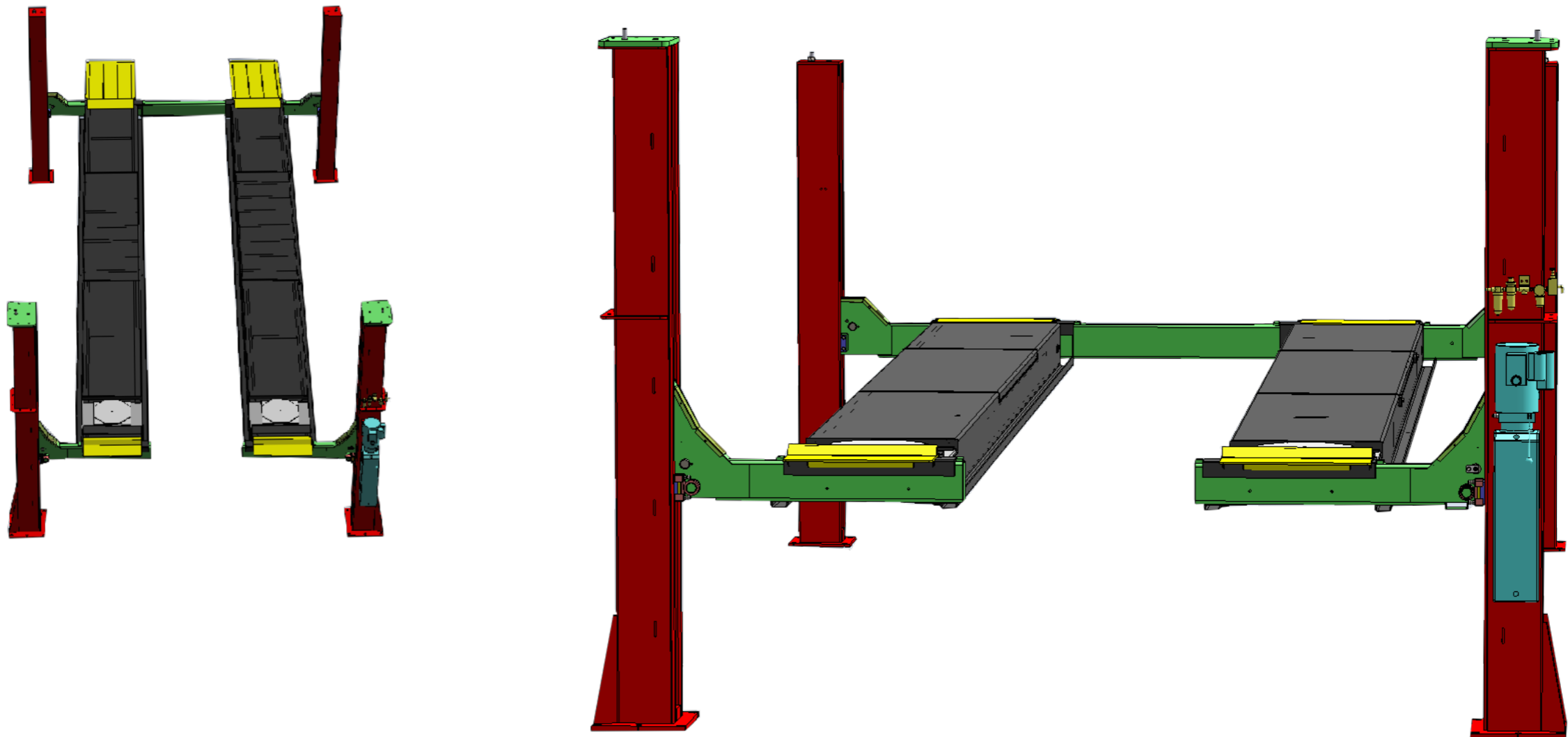

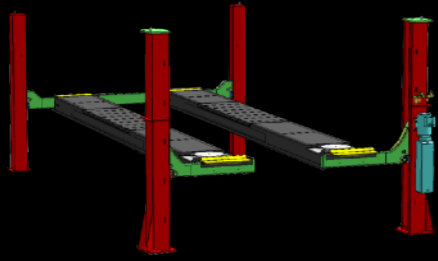

New 15,000 lb. **Open Front** 4 post Alignment Lift Has Arrived!





4 POST
 TLS415ALOXR1 / TLS415FDOXR1

AUTOMOTIVE AND LIGHT TRUCK GENERAL SERVICE
100% DESIGNED AND BUILT IN NORTH AMERICA

THE ONLY 4 POST WITH "CAMBER NEUTRAL" TECH-

PIVOTAL

4 POST OPEN FRONT
ALIGNMENT OR SERVICE
15,000 LB. / 6.8T CAPACITY

DOUBLE WALL RUNWAYS WITH "Z" RAILS,
BUILT IN RADIUS PLATE POCKETS & REAR SLIP PLATE

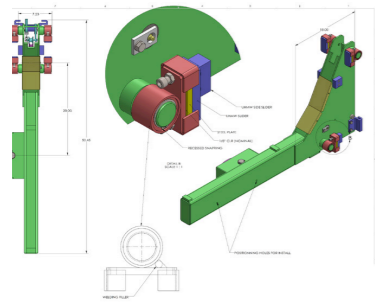

PATENT PENDING



"CAMBER NEUTRAL" TECHNOLOGY

ADJUSTABLE ARM BEARINGS

OPTIONAL ACCESSORIES



Jacking beam TLS-RJ75

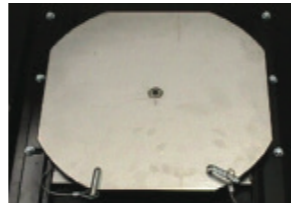

Stainless Steel Turnplates TLSSTP

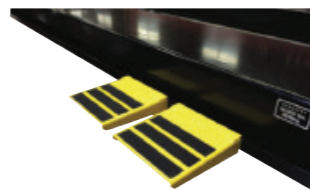

Runway Step Platforms TLSMWS

4 POST ALIGNMENT
15,000 LB. / 6.8T CAPACITY

ALIGNMENT OR GENERAL SERVICE
210" OR 237" / 5.3M OR 6M LONG RUNWAYS

AT TLS WE BUILD LIFTS THAT LAST LONGER, PERFORM BETTER & COST LESS TO OPERATE

SPECIFICATIONS	
Capacity	15,000 lbs / 6.8T
Overall Length Extended Model	285-1/8" / 7242 mm
Overall Length Standard Model	257-7/8" / 6550 mm
Deck Length Extended Model	237" / 6020mm
Deck Length Standard Model	210" / 5334mm
Overall Width	143"3632mm front /137 1/2" / 3493mm rear
Deck Width	23" / 584mm
Lowered Height	8-3/8" / 213mm
Raised Height	75" / 1905mm
Min. 4 Wheel Align. WB	88-1/2" / 2248mm
Max.4 Wheel Align. WB	164-1/2" / 4178mm
Max. 2 Wheel Align. WB	220-1/2" or 193-1/2" / 5601mm or 4915mm
Max. Service WB	232" or 205" / 5892mm or 5207mm
Lift Time	70 seconds
Power Requirement	230V - 60Hz - 1 Ph - 20amp
Shipping Weight	5,000 lb. / 2.3T
Part Number	TLS415ALOXR1 / TLS415FDOXR1

- FEATURES**
- Built to higher quality standard; 100% North American made - premium US Bucher 2HP / 1.5kw power unit.
 - Corrosion resistant protection - steel components are wheel-a-brator shot blasted and acid washed before a "double bake" powder coat finish is applied.
 - Superior structural strength provides longer life and more precise alignments - Non flex double wall 23" / 584mm wide runways with built in "Z" rail. Heavy duty 10" x 8-3/8" x 1/4" wall / 254mm x 213mm x 6mm wall columns and 3" x 8-1/4" / 72mm x 210mm tube traverse beams.
 - Greater flexibility with more models to chose from - Available in two runway lengths with built in wheel alignment or service deck. Lift can be ordered in red or blue.
 - Premium options and accessories can expand the capabilities and service life - Stainless steel radius plates and rear steer plates, built in tire inflation hoses, removable work steps, LED runway lighting and premium long life 5 year warranty HD jacking beams
- Lower maintenance costs - Zirk style grease fittings at all 1-1/2" / 38mm plated hinge pins. Runway under rear slip plates is open to prevent water and dirt collecting. Thirty 7/8" / 22mm enclosed plated steel slip plate balls provide better support with minimal maintenance.
 - Extended Life "Non Twist" Cable design - Machined steel nickel plated 9" / 229mm pulleys with bronze self lubricating bushings. Non spin fatigue resistant 9/16" / 14mm cables are routed on double stacked pulleys (versus four stacked) to reduce stress and wear.
 - Low pressure hydraulics provides longer life - 4"ID x 65" / 102mm ID x 1651 mm cylinder is mounted under the runway and use a premium "Parker" seal and wear ring with chrome plated plunger shaft.
 - Designed for optimum productivity - OPEN FRONT design provides clear access. Single point control with stainless steel cylinder air releases engage 12 locking positions. Adjustable locking ladders 81" x 2-3/4" x 3/8" / 2057mm x 70mm x 9.5mm thick allow for accurate levelling. Power unit can be mounted on a front or rear column.

ADDITIONAL FEATURES



Pulley and cables

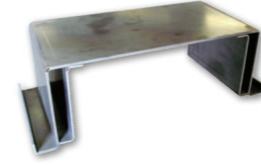

Double wall deck with Z rail

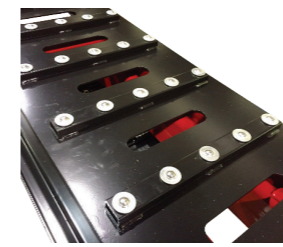

Open runway slots under rear slip plates

EQUIPMENT FOOTPRINT

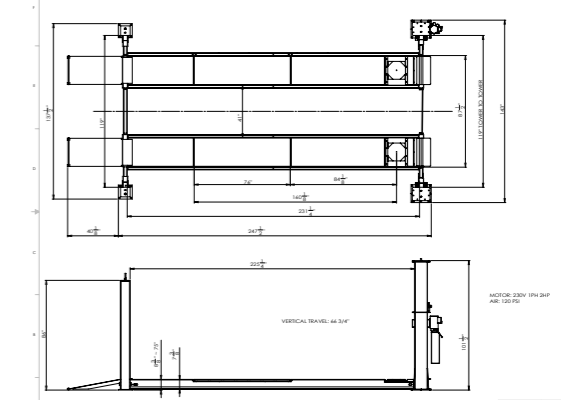

CONTACT US NOW WWW.TLSLIFTS.COM OR CALL (877) 799-5438



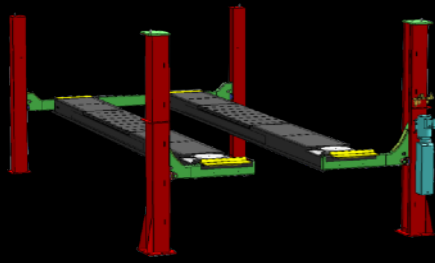

TLS Open Front Four Post Camber Neutral Technology

Design Features :

- * Adjustable Front Arms
- * Precise Alignment Readings
- * Reduced Maintenance Costs - pulleys & cables & last longer
- * Replace bearings without removing arms



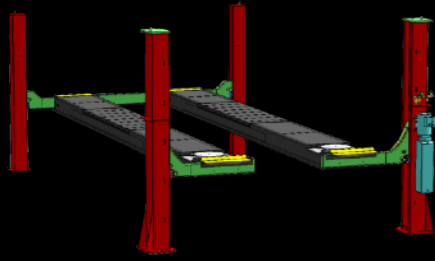

TLS Open Front Four Post Camber Neutral Technology

Premium Features :



MACHINED PULLEYS
9/16" PREMIUM CABLE



AIR REGULATOR/OILER
WATER TRAP STANDARD



23" WIDE DOUBLE
WALL RUNWAYS WITH
Z RAIL BUILT IN



FLIP UP REAR SLIP
PLATE LOCKS

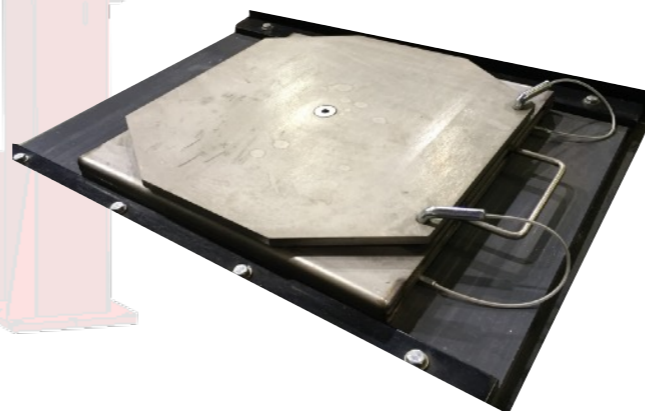

POLYETHYLENE RADIUS
PLATE POCKET LINERS

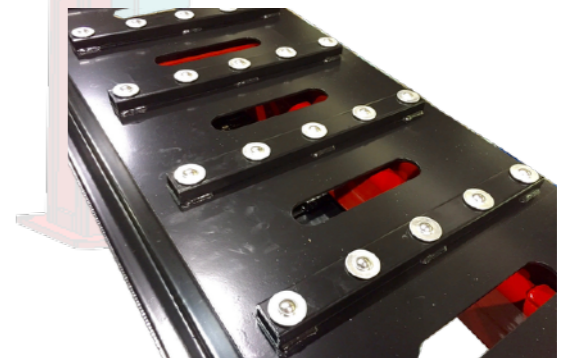

RUNWAYS OPEN UNDER
SLIP PLATES WITH
7/8" STEEL ROLLERS

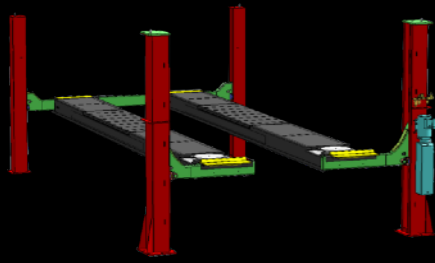

TLS Open Front Four Post Camber Neutral Technology

SPECIFICATIONS	
Capacity	15,000 lbs / 6.8T
Overall Length Extended Model	285-1/8" / 7242 mm
Overall Length Standard Model	257-7/8" / 6550 mm
Deck Length Extended Model	237" / 6020mm
Deck Length Standard Model	210" / 5334mm
Overall Width	Front 143" / 3632mm/ Rear 137 1/2" 3493mm
Deck Width	23" / 584mm
Lowered Height	8-3/8" / 213mm
Raised Height	75" / 1905mm
Min. 4 Wheel Align. WB	88-1/2" / 2248mm
Max.4 Wheel Align. WB	164-1/2" / 4178mm
Max. 2 Wheel Align. WB	220-1/2" or 193-1/2" /
Max. Service WB	232" or 205" / 5892mm or 5207mm
Lift Time	70 seconds
Power Requirement	230V - 60Hz - 1 Ph - 20amp
Shipping Weight	5,000 lb. / 2.3T
Part Number	TLS415ALOXR1/ TLS415FDOXR1

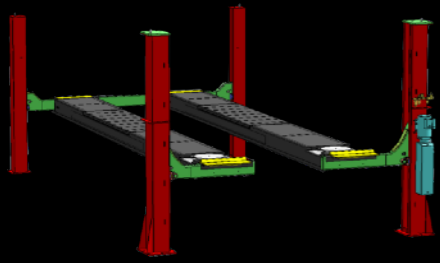

TLS Open Front Four Post Camber Neutral Technology

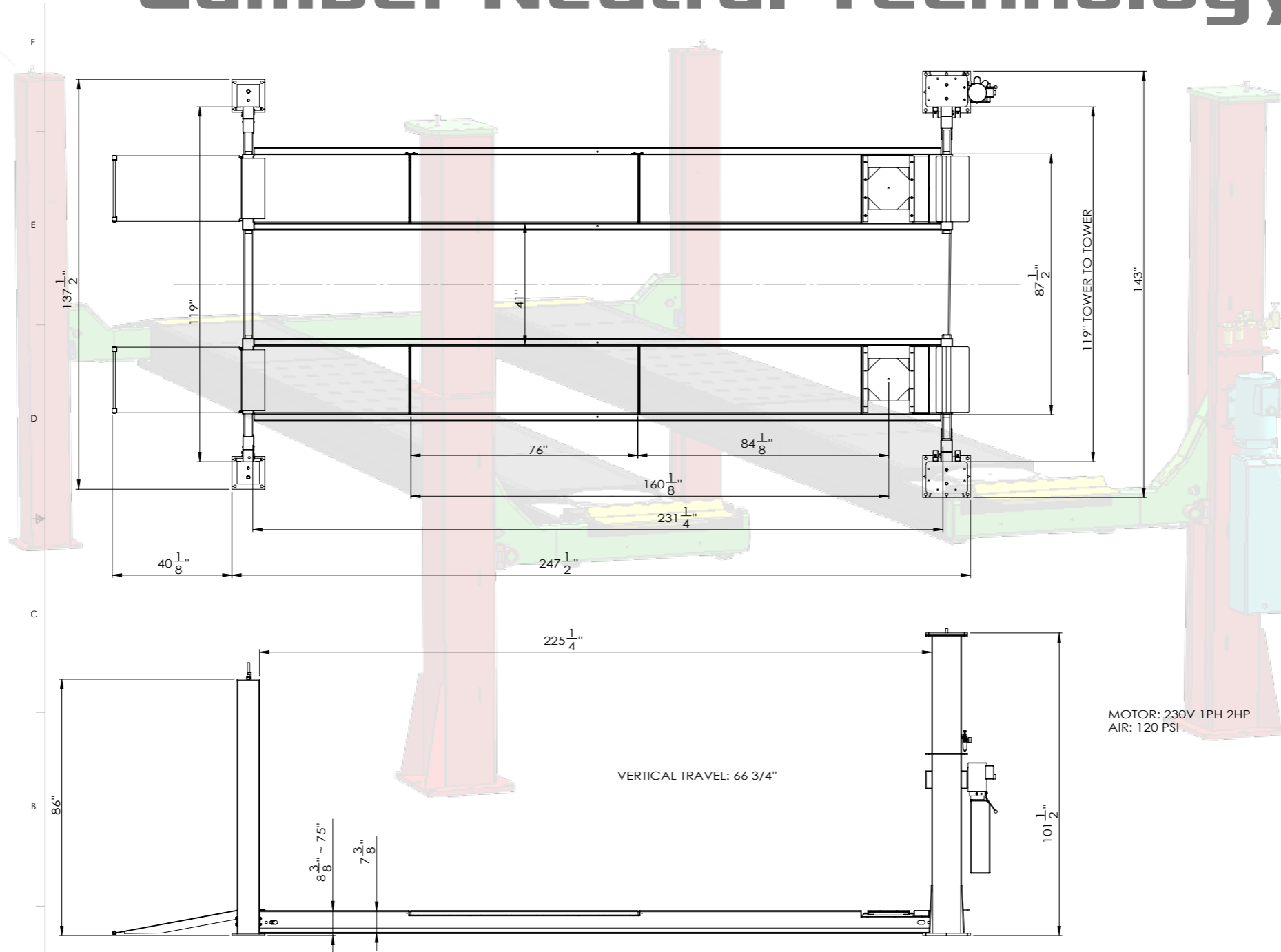

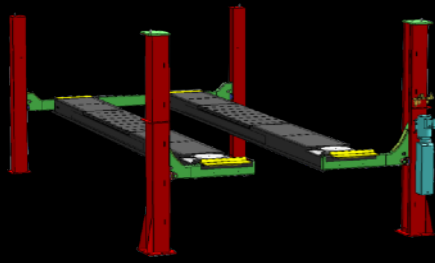

Runway length 210" or 237"

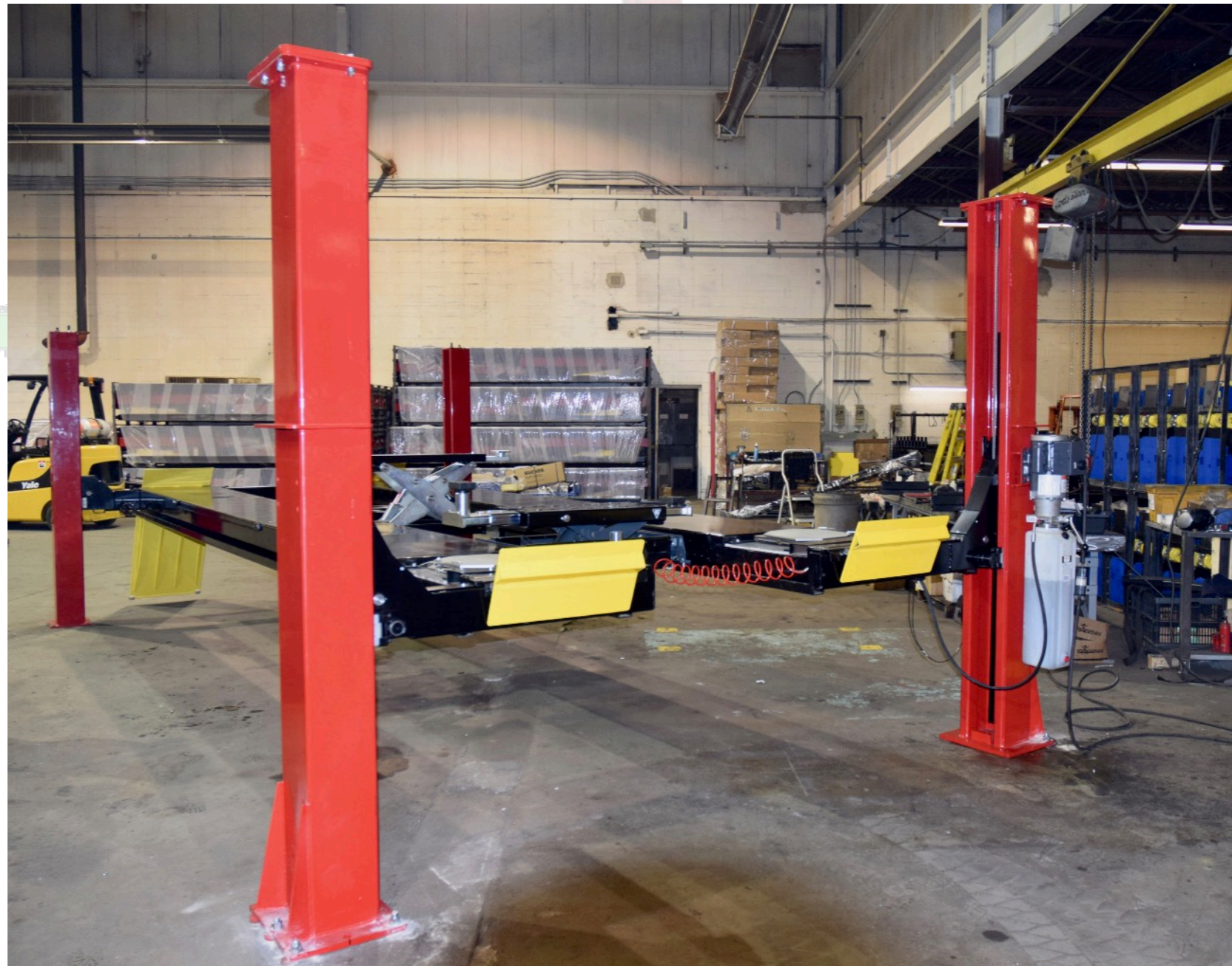

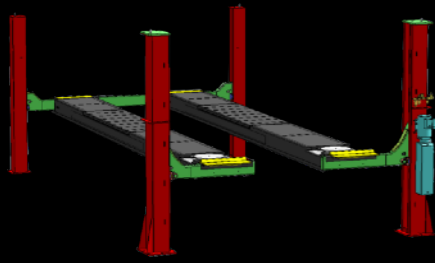

Width of Runways 23" wide with built in Z Rail

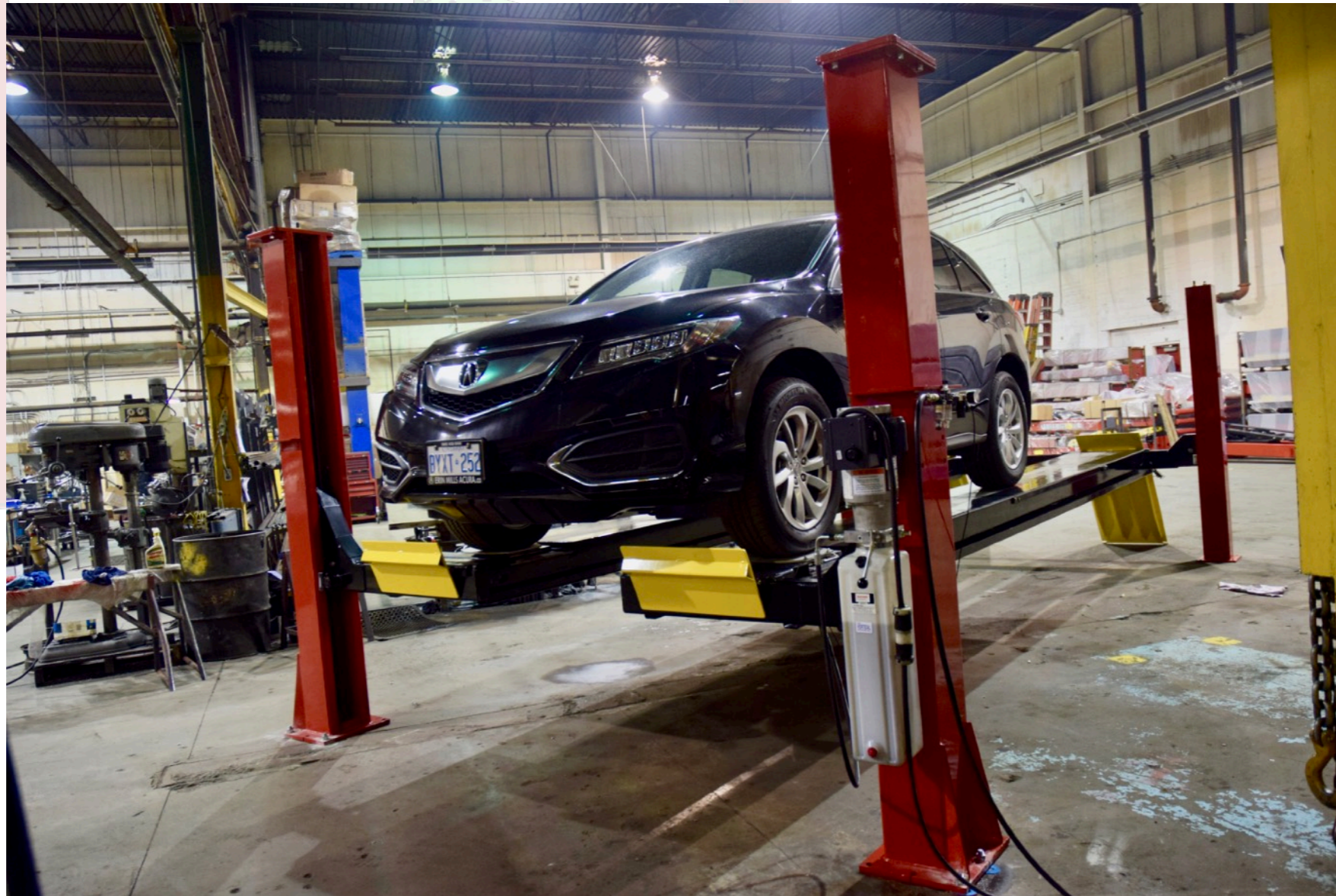

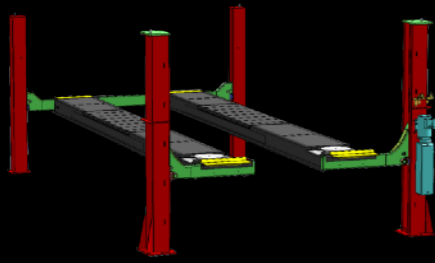

Lifting height from floor 75" 8 3/8" collapsed height

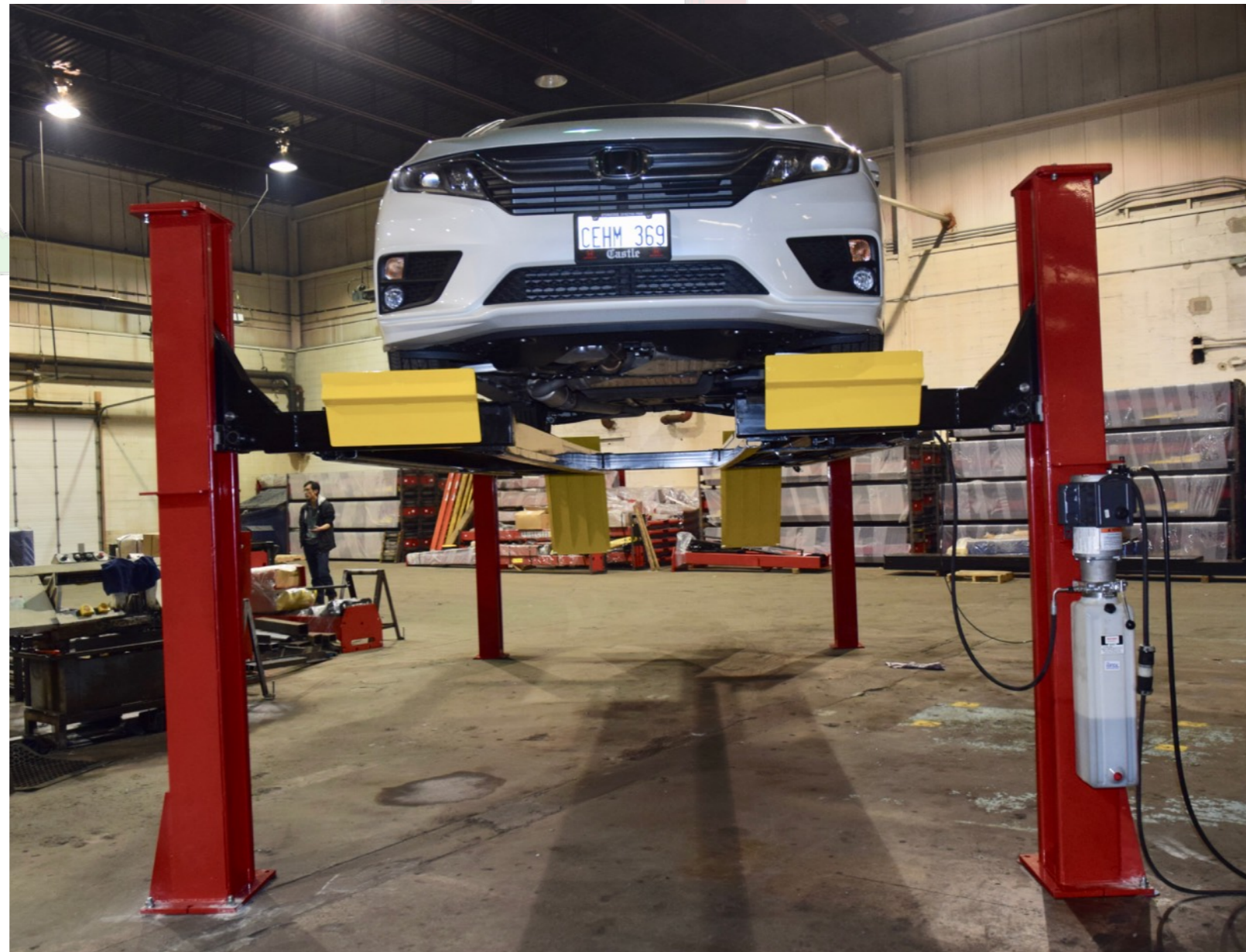

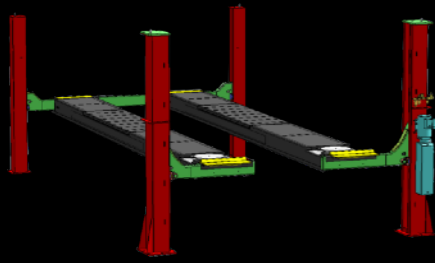

**Overall maximum foot print
143" (front) x 285 1/8" (extended)**



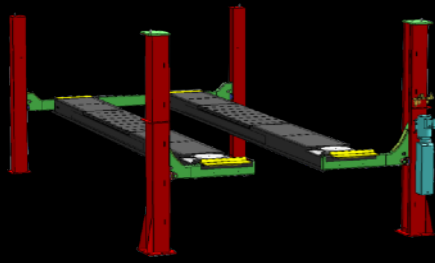

ALI Testing - Proof Load 22,500 lb.

Camber Neutral Technology



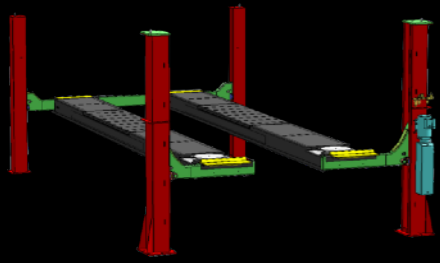

ALI Testing - Proof Load 22,500 lb.

Camber Neutral Technology



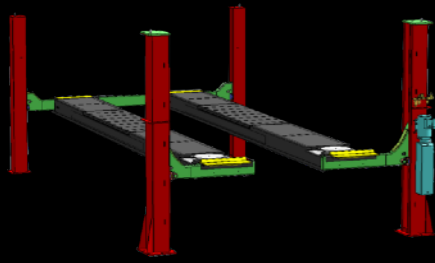

TLS Exclusive Design

Camber Neutral Technology

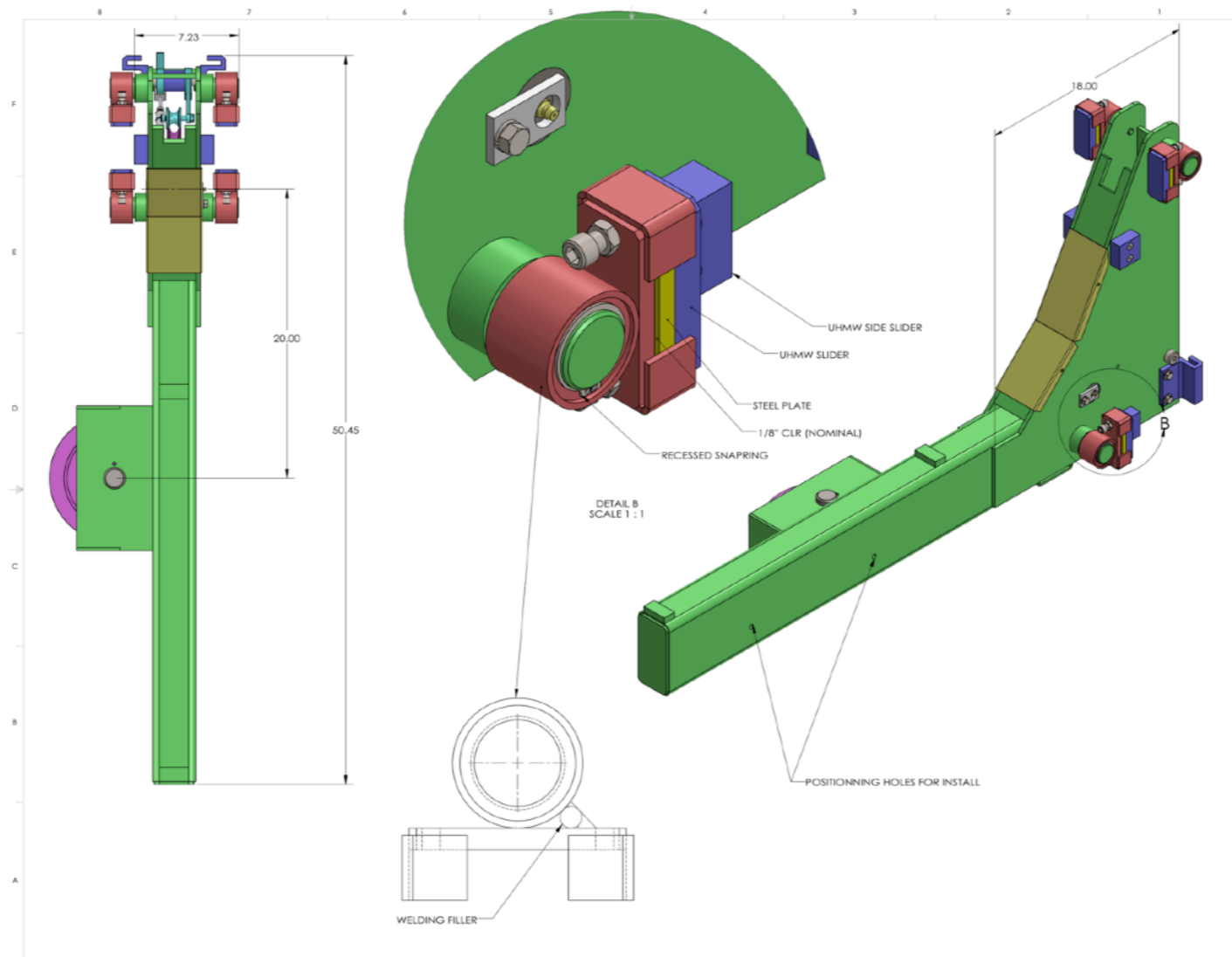

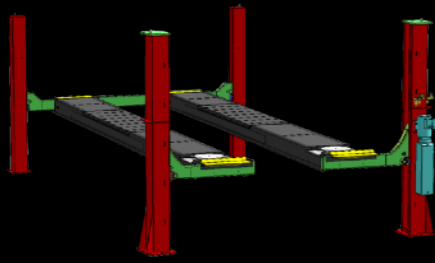

TLS Exclusive Design

Camber Neutral Technology

